

Detecting Hard-to-Find Contaminants In Small to Medium Products

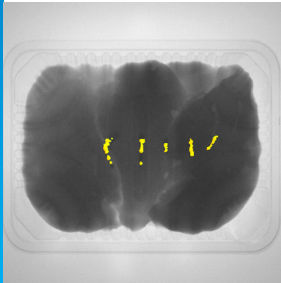

Premium Product Safety

The X52 dual energy system offers remarkable detection capabilities for low-density contaminants like calcified bone, glass and rubber, especially in complex applications, enhancing product integrity and supporting brand protection.

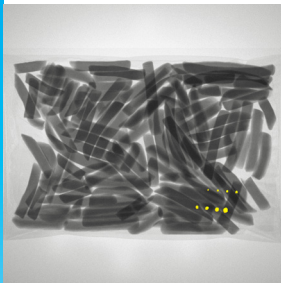

Effective Quality Control

The X52's Advanced Material Discrimination software (AMD) is our proprietary software for dual energy applications. AMD detects low-density contaminants in products with high contrast differences, providing you with high quality end products even in noisy, complex applications.

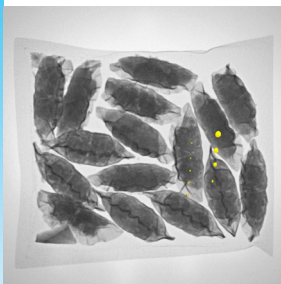

Enhanced Productivity

The X52 maximizes production uptime by combining superior industrial design with a range of productivity tools. These include simplified cleaning routines, an intuitive user interface, and a reliable set of state-of-the-art subsystems.

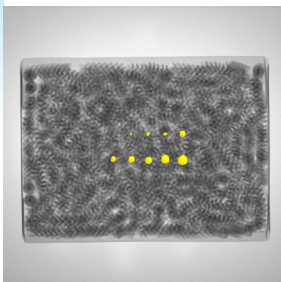

Compliance Made Easier

The X52 has built-in software capabilities that allow full product traceability through a recorded image database. This can be accessed directly with the system's interface or connected remotely to ProdX, or any of the most common network protocols.



The X52 Dual Energy X-ray System Premium Product Inspection

The X52 is a premium, dual energy, x-ray inspection system designed to identify contaminants even in complex applications such as noisy, overlapping products.

Built with cutting edge HiGain+ DE technology, the X52 provides an unprecedented level of detection of low-density contaminants, like calcified bone, rubber and glass in food applications.

Technical Details

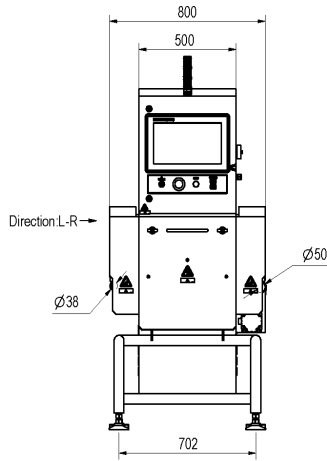

800 mm, X52 Short System Diagram

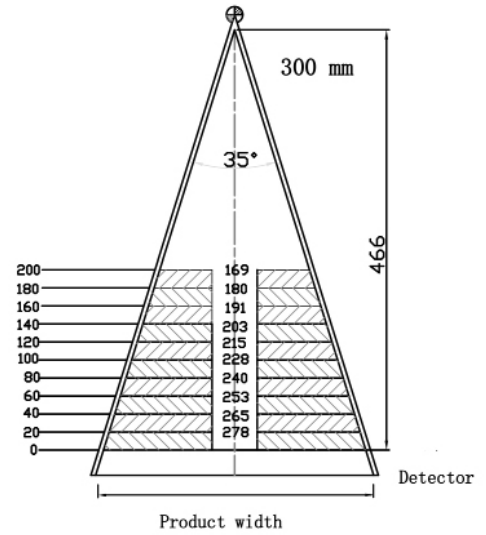
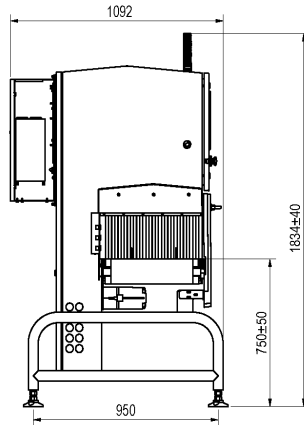

X52 Beam Size Diagram

Specification Table

Feature	X52 Specifications
Contamination Detection	Metal from 0.3 mm, shards of glass under 2 mm and stones, bones and several low-density materials
Product Quality Tools	Completeness check, product fill level, clip and product trapped in seal detection*
Compliance	User management, segregation of rejected goods, reject confirmation including manual verification, bin full and almost full sensors. Product validation feature and performance verification routine (PVR). Fully lockable inspection tunnel.
Conveyor Speed	10-100 m/min**
Lane Configurations	Single and Multi-lane
Throughput Rate	1000 products/min**
Maximum Product Height	200 mm
Product Set-up	Automatic configuration and fast set-up with ContamPlus
X-ray Detector	300 or 400 mm length, HiGain+ DE Technology
X-ray Generator	Optimum Power 100 W, up to 84 kV, up to 1.2 mA Beryllium tube
Operator Safety	X-ray emissions <1uSv/hr, fully contained within construction, lead-free curtains with non-contact safety interlocks
Cooling Method	Air Conditioner
Environmental Conditions	Operating humidity up to 90% RH. Operating temperature 5-40°C
Power Supply	208-240 Vac, 1 Phase, 50-60Hz, 10A max
Pneumatic Supply	6 Bar(g) clean air supply required for air operated reject system. With built-in pressure monitoring
Hygienic Features	Durable body in 304 Stainless Steel, with anti-accumulation sloped surfaces. Finish 180-240 Grit brushed on main components. Toolless removable belt and curtains. Integrated cable management
External Interface	Customer dedicated 5 digital inputs 8 digital outputs, dependent on product configuration
Ingress Protection	IP65, IP66 or IP69 for main enclosure and conveyor. Air conditioner IP34
Operating Height	750 mm, 850 mm, 950 mm, 1050 mm or 1150 mm (+/- 50 mm)
System Conveyor	FDA and EU food use approved TPU conveyor belt 90 W motor unit, 38 mm diameter infeed roller, 50 mm diameter outfeed roller
System Length	800, 1300, 1800 or 2000 mm
Screen Display	15.6" Capacitive Touchscreen display (16:9 aspect ratio)
Reject Type*	Pusher, Air blast
Operating System	Concurrent algorithms Flex system software with Microsoft Windows 10 (upgradable via USB)
Traceability Options	Event log tracks changes of parameters, users and products. Product traceability through recorded image database, accessed via USB, ProdX, Ethernet/IP
Product Handling	Optional infeed or full-length guide rails, optional in-feed and out-feed lights
Service	Remote support ready, 5-year generator warranty, spare parts kits and service plans

*dependant on application

**dependant on product dimensions

METTLER TOLEDO Group
 Product Inspection Division
 Safeline X-ray
 Local contact: www.mt.com/contacts

www.mt.com/safeline-xray

For more information

Subject to technical changes
 © 01/2024 METTLER TOLEDO. All rights reserved
 PI-XR-DS-EN-012024